

“Manufacturing Moving Dollies Since 1953”

ADAMS ASSOCIATES

1960 Stratford Avenue

Bridgeport, Connecticut 06607

Phone: 203-333-0106 • Fax: 203-333-3737



Website: www.adollie.com

Email: adamsassoc@adollie.com

TABLE OF CONTENTS

A	F	Piano Board..... 21
“A” Frame Dollie 23	Fiberglass Ramps 24	Piano Dollie 1,4
Aluminum Platform Trucks ... 22	File Dollie 18	Piano Straps 7
Aluminum Handtrucks..... 12-15	Flatbed Tie Down Straps 6	Platform Dollie 3
Appliance Handtrucks.... 9,10,11	Forearm Forklift 21	Platform Truck 22
ATV Dollie 4	Furniture Movers..... 19	Plywood Dollie..... 3
Auto Loader Ramps 24	Furniture Pads and Covers 8	Pry Bar 22
Auto Transit Strap 6	Furniture Skates 21	
B	H	R
Banding Film 20	“H” Pattern Dollie..... 2	Rails 4
Bars 6	Hand Trucks 9-15	Ramps 15,24,25
Baskets 29	Heavy Duty Panel Mover 23	Ratchet Straps 6,7
Beams..... 6	Hump Straps..... 7	Raymond Products .. 16,17,18,23
Beam Sockets..... 7	High Rise Rubber End Dollie .. 4	Reefer Trucks 10,11
Big Wheel Attachment 11		Rol-A-Lift 19
Bins 28	J	Rope Tie Off..... 7
Blankets..... 8	“J” Bars 22	Rubber Bands..... 7
Boston Dollie 2	Jack Handle Cargo Bar 6	Rubber Band Holder 7
Branding Dollie..... 1	Jumbo Carpeted Dollie 2	Rubber End Dollie 1,4
C	K	Rubber Fasteners 6
Canvas Baskets..... 29	Karry King Lever Lift..... 18	
Cargo Bars 6		S
Cargo Restraint Systems 6,7	L	Safe Jacks..... 19
Carpeted Dollie 1,2	Library Bin..... 28	Samson Book Cart 28
Casters..... 1,5	Logistic Track..... 6	Sewn Loop Webbing 7
Chicago Rubber End Dollie 3		Shoring Beams 6
Computer Bins 28	M	Skates 21
Cotton Tie Webbing..... 7	Machine Dollie..... 2	Space Saver Pad 8
Covers 8	Machine Rollers 21	Stair Climbing Handtruck 9
Convertible Hand Truck 15	Masonite..... 23	Steel Handtrucks 11
Curb Ramp 15	Melcher Ramps 24	Steel Strapping 20
D	Mini Cargo Strap..... 7	Stevens 10,11
“D” Ring 7	Moleskin Pads 8	Straps..... 6,7
Desk Lift 18		Stretch Film..... 20
Desk Riser Box 17	N	
Dockboards 26	Nylon Tubular Webbing 7	T
Dockplates..... 27		Tape 20
Dollies 1-4	P	Tape Guns 20
Dollie Converter Rails 4	Padded Covers..... 8	Tarp Straps 6
Door Jamb Protectors..... 8	Pallet Pads 8	Tie Webbing 7
E	Pallet Puller 21	Tow Hooks 23
“E” Straps..... 6	Pallet Truck 21	Track 6
	Pan Fittings 7	Tri-Pod Dollie 4
	Panel Movers..... 16,17,23	
		W
		Warehouse Pads 8
		Webbing 7
		Wooden Platform Truck 22

RUBBER END DOLLIE



We recommend 4" Hi-Tech Rubber casters for any dollie requiring a 4" caster, it is the perfect caster to use on a dollie. For information and description of dollie casters, see page 5.



Adams manufactures the finest rubber end dollie you can buy. All around heavy duty frame has 1-1/16" kiln dried hardwood siderails bullnosed on both the inside and outside edges for smooth handling. 3" wide endboards are covered with a heavy non marking rubber cap with a raised lip to protect walls. All bolts are countersunk beneath the surface of the wood. Dollies are equiped with your choice of quality made casters for trouble free moves. Casters are secured with nylon lined locknuts that will not loosen or back off. 18" x 30" frame.

Model RE - 35HTR - 3 1/2" Hi-Tech Rubber Wheel - 900 lb. capacity

Model RE - 4HTR - 4" Hi-Tech Rubber Wheel - 1000 lb. capacity

Model RE - 4HR - 4" Hard Rubber Wheel - 1100 lb. capacity

Model RE - 40RAL - 4" Aluminum Side Core Wheel - 1000 lb. capacity

CARPET END DOLLIE - 3" CASTER



The most used and abused dollie in the industry. 18" x 30" frame is made from 7/8" thick seasoned hardwood. Siderails are 4" wide and bullnosed on both edges. The endboards are 6" wide and fully carpeted. Casters are secured with nylon lined locknuts that will not loosen or back off.

Model CD - 3HR - 3" Hard Rubber Wheel - 1000 lb. capacity

Model CD - 3HTR - 3" Hi-Tech Rubber Wheel
800 lb. capacity

CARPET END DOLLIE - 4" CASTER



This dollie had the same frame size and construction as the Carpet End 3" dollie but with a 4" caster. The larger 4" diameter wheel will roll more easily on carpet and perform better on rough or uneven surfaces.

Model CD - 4HR - 4" Hard Rubber Wheel - 1100 lb. capacity

Model CD - 4HTR - 4" Hi-Tech Rubber Wheel
1000 lb. capacity

CUSTOM DOLLIES

We can customize any dollies shown to your exact spec's or make up dollies to any design you need. We have made small 12" x 12" dollies for a parts manufacturer and up to 9 foot long dollies for moving helicopter blades. Let us quote your special needs.

BRANDING

Hot Brand Stamping marks your company name deep into your dollie for a permanent impression that won't sand off or paint won't cover.



JUMBO OFFICE MOVE DOLLIE



We manufacture two types of Jumbo Dollies, our first style is the traditional 18" x 30" dollie made from 7/8" hardwood, with 18" x 12" carpeted ends and bullnosed edges for smooth handling.

Our second model is the West Coast style 19" x 32" dollie made from select 2" x 4" fir siderail boards with 19" x 12" carpeted plywood ends. Both models have 4" Hi-Tech rubber casters standard.

Model JD - 1830 - 4" Hi-Tech Rubber wheel - 1000 lb. capacity.
(Hardwood Frame) Traditional Style

Model JD - 1932 - 4" Hi-Tech Rubber Wheel - 1000 lb. capacity.
(2" x 4", Plywood Frame) West Coast Style

H PATTERN DOLLIE



This dollies 30" siderail boards are fitted with heavy duty non marking rubber belting for a secure grip on furniture and files even on the most difficult moves. Endboards and casters are set back 1-3/4" from end of dollie. This dollie has an 18" x 30" frame constructed of 7/8" kiln dried hardwood boards 4" wide. All bolts are countersunk.

Model HD - 35HTR - 3 1/2" Hi-Tech Rubber Wheel - 900 lb. cap.

Model HD - 4HTR - 4" Hi-Tech Rubber Wheel - 1000 lb. cap.

Model HD - 40RAL - 4" Aluminum Side Core Wheel - 1000 lb. cap.

BOSTON DOLLIE



This dollie is constructed of 7/8" thick seasoned hardwood with the 30" siderail boards fully carpeted and used as the top surface of the dollie. It has an 18" x 30" frame with a 4" siderail and 6" endboards. Like all our dollies, the casters are fastened with nylon lined locknuts that will not loosen or back off.

Model BD - 3HR - 3" Hard Rubber Wheel - 1000 lb. capacity

Model BD - 3HTR - 3" Hi-Tech Rubber Wheel - 800 lb. capacity

Model BD - 4HTR - 4" Hi-Tech Rubber Wheel - 1000 lb. capacity

HEAVY DUTY MACHINE DOLLIE



This dollie is made to support and move heavy equipment. Its 18" x 30" hardwood frame has 1-1/16" siderail boards 8" wide, this leaves a 2" handhold space in the center for lifting the dollie. The endboards are 18" x 12" which make a large stable base for equipment. Carpeted ends prevent scratching or marring. The dollie height is only 6-1/2" from the ground, this design allows a heavy machine to be lifted easily onto and off of the dollie. A 3" low profile wheel is used, it is a high strength high impact wheel that features a roller bearing axle and an extra wide 2" treadwidth. This is a super tough wheel that provides excellent floor and carpet protection with a high load capacity.

Model HD - 3P - 3" Low Profile Wheel - 3600 lb. capacity



CHICAGO RUBBER END DOLLIE

Popular dollie throughout the Midwest. The 18" x 32" frame has the casters set in slightly on both ends, this allows the dollies to rest lengthwise on top of each other, countersunk bolting prevents any damage to the rubber caps. The extra heavy endboards are mortised and triple bolted. This unique construction allows for tight and easy stacking, stacks are 23" wide which means less room on the truck and on the job. Constructed of 1-1/16" kiln dried hardwood with bullnosed edges.

Model CRE - 35HTR- 3-1/2" Hi-Tech Rubber Wheel
900 lb. cap.

Pictured with optional carpeted deck and hand hole cutout

PLYWOOD PLATFORM DOLLIE

This dollie's deck is constructed of smooth sanded 3/4" plywood. It has 5/4 lumber underbracing on all four sides for added strength with countersunk bolting for a smooth deck. Plywood dollies offer a great combination of strength and economy and are very easy to custom make into any size you need. Available with optional hand hole cutout for easier lifting. Also available with fully carpeted deck and sides. Here are four of our more popular sizes.

- 18 x 30
- 24 x 48
- 32 x 48
- 24 x 60

Model PPD - 3HTR - 3" Hi-Tech Rubber Wheel - 900 lb. cap.



PLATFORM DOLLIE



Adams manufactures two popular versions of a platform dollie. These dollies are useful in many different warehouse and industrial applications. Both dollies are made from 7/8" thick kiln dried hardwood with all bolts countersunk for a smooth surface. The Flush Top dollie has an open center hardwood frame. Its 4" wide siderail boards are doubled which adds strength and creates a flush surface. The Solid dollie is constructed of select hardwood boards fitted together to form a solid top, this makes a very strong and versatile dollie.

Flush Top

Model FD-3HR
3" Hard Rubber Wheel
1000 lb. capacity.

Solid Top

Model ST-3HR - 3" Hard Rubber Wheel 1000 lb. capacity.
Solid top also available with 24" x 36" Frame
Model 2436ST-4HTR - 4" Hi-Tech Rubber Wheel
1000 lb. capacity

HIGH RISE RUBBER END DOLLIE



This dollie is useful in moving desks, appliances or any equipment with long legs, it is equipped with 5" Hi-Tech casters and double thick rubber cap endrails. This gives the dollie a height of 10" which allows clearance on most equipment; if 10" is not enough height we can add more endboards to the dollie to achieve the height you need. 18" x 30" Kiln Dried Hardwood Frame 1 1/16" thick.

Model HRR - 5HTR - 5" Hi-Tech Rubber Wheel
1100 lb. capacity

ATV DOLLIE



Stands for all terrain vehicle, this unique dollie will roll over difficult surfaces such as gravel driveways and lawns with ease. 6-8" air filled pneumatic casters provide a smooth cushioned ride. Great for moving bulky, heavy objects such as pianos, display cases, appliances, etc. 3 rubber caps grip and protect your load. Dollies lowered center wheels can make 360° turns. Frame is 1 1/16" Kiln Dried Hardwood 18" wide x 42" long

Model ATV - 8" Air filled pneumatic wheel
2000 lb. capacity

DOLLIE CONVERTER RAILS



Makes any dollie a panel mover, rails slip on and off in seconds. This is the original design, not an imitation. Rails are made of high tempered solid steel which has great strength and flexibility, far superior to hollow tubular steel. Bent steel design has no sharp angles or wedges which

can damage panels. Heavy rubber coating is Bonded onto rails and will not tear off. Sold in sets of two.

Each rail weighs 12 lbs. and is 13" wide x 38" tall.
800 lb. capacity

TRIPOD DOLLIE



Move grand pianos, heavy refrigerators, stoves and other bulky items without effort with one of these dollies under each leg. They are made of cast iron, enriched with steel for strength and durability.

Specifications:

- Wheels - 3-2" diameter swivel, hard rubber or steel
- Body - 2" deep well-tapers 5" at top to 3-3/16" at bottom. 9" overall size- 3" floor height
- Weight - 8 1/2 lbs.
- Weight capacity - hard rubber wheel - 375 lbs. (Steel wheel - 450 lbs.)

CASTERS

A dollie is only as good as the casters it rides on and we use only the best: Albion, Colson, Shepherd, Faultless and Trio Pines are some of the brand name casters we use on our dollies. These are long established companies with a proven track record of manufacturing reliable, durable casters. We also stock larger 5", 6" & 8" casters from these same companies. Call us for information on any style of caster, we are very knowledgeable and for a price quote you'll find difficult to match.



3" HARD RUBBER

- 3" High impact hard rubber wheel
- Self lubricating wheel bearing
- Single ball raceway
- 1 1/4" Tread width
- 3 7/8" Overall height
- 250 lb. capacity



HI-TECH RUBBER WHEELS

Offer the advantages of both hard and soft tread materials in a single wheel. Like a hard tread wheel, Hi-Tech wheels roll easily and are very durable. Like a soft tread wheel, it rolls quietly, is totally non marking to protect floors and absorbs shock to provide a cushion ride.



3" LOW PROFILE

- 3" Phenolic wheel
- Easy start and swiveling capabilities
- Extremely durable wheel with high impact resistance and high weight capacity
- Roller bearing - wheel bearing
- Double ball raceway
- 2" Tread width
- 4" Overall height
- 900 lb. capacity



4" HARD RUBBER

- 4" High impact rubber wheel
- Self lubricating wheel bearing
- Double ball raceway
- 1 1/4" tread width
- 5 1/8" Overall height
- 275 lb. capacity



4" RAL

- 4" grey soft moldon rubber bonded to aluminum core
- Provides soft cushion ride with non marking tread
- Ball bearing - wheel bearing
- 1 1/4" tread width
- 5 1/8" overall height
- 250 lb. capacity



5" QUIET POLY

- 5" polyurethane wheel locked onto a polymer core
- High load capacity with excellent floor protection
- Roller bearing wheel bearing
- Double ball raceway
- 2" tread width • Grease fittings
- 6 1/2" Overall height
- 750 lb. capacity



6" HEAVY DUTY

- 6" black phenolic wheel
- Economical, reliable, with good load capacity
- Roller bearing wheel bearing
- Double ball raceway
- Grease fittings
- 2" Tread width
- 7 1/4" overall height
- 900 lb. capacity



6" HEAVY DUTY RUBBER ON STEEL

- 6" cushion rubber tread bonded to a cast iron core
- Highly shock absorbing with quiet movement and floor protection
- Roller bearing wheel bearing
- Double ball raceway
- Grease fittings
- 2" Tread width
- 7 3/8" overall height
- 500 lb. capacity



6" HI-TECH BALLOON

- 6" soft hi-tech rubber wheel
- Bonded to polyolefin core
- Quiet rolling - non marking shock absorbing with a rounded tread for superior mobility
- Roller bearing wheel bearing
- Double ball raceway
- Grease fittings
- 2" tread width
- 7 1/2" overall height
- 600 lb. capacity



8" PNEUMATIC

- 8" 4 ply - air filled tire
- Offers greatest possible protection to both load and floors
- Roll delicate equipment over rough terrain with ease
- Radial ball bearing - wheel bearing
- Double ball raceway
- Grease and air fittings
- 2" tread width
- 10" overall height
- 410 lb. capacity

4" HI-TECH RUBBER

4" grey non-marking thermoplastic elastomer soft tread permanently bonded to durable polyolefin core

- Rejects floor debris - resists flat spots even when equipment rests idle on dollie over time
- Precision sealed ball bearing wheel bearing - never needs grease
- Double ball raceway
- 1 1/4" tread width
- 5 1/16" overall height
- 250 lb. capacity

HI-TECH RUBBER CASTERS ALSO AVAILABLE IN THESE SIZES

3" WHEEL

- 4 1/4" Overall height
- 200 lb. capacity

3 1/2" WHEEL

- 4 3/16" Overall height
- 225 lb. capacity

5" WHEEL

- 6 3/16" Overall height
- 275 lb. capacity



CARGO RESTRAINT SYSTEMS

CAM BUCKLE "E" STRAPS

RATCHET BUCKLE "E" STRAPS

TWO STYLES AVAILABLE

- Cambuckle - Breaking Strength 2500 lbs. - working load limit - 833 lbs.
- Ratchet Buckle - Breaking Strength 3000 lbs. - working load limit - 1000 lbs.
 - One piece spring end fitting
 - 2" Nylon webbing
 - Fits series "E" or "A" Track
 - 3 color coded lengths
 - 12' - Yellow
 - 16' - Grey
 - 20' - Blue

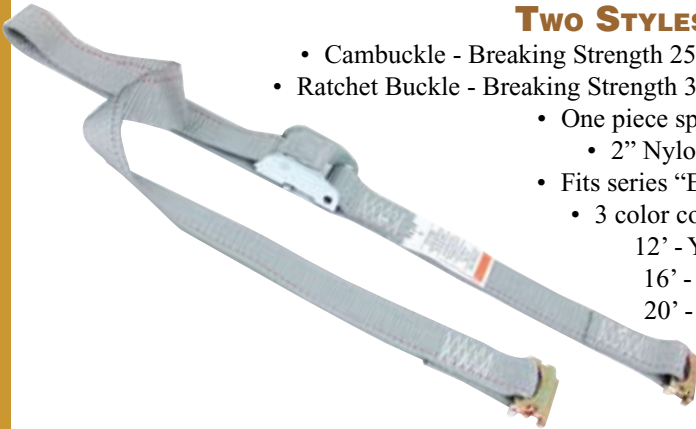

ALUMINUM SHORING / DECKING BEAMS

These adjustable beams come in two sizes. As shoring support they have a 3000 lb. working load capacity, as decking support a 1000 lb. capacity.

Model	Adjustable Length	Weight
85	84.5" to 95.4"	16 lbs.
102	90.8" to 101.7"	18.8 lbs.

LOGISTIC TRACK



Heavy duty 12 gauge steel, horizontal "E" track in 10 ft. lengths.

JACK HANDLE CARGO BAR

Constructed from tempered, rust proofed steel. Features heavy duty automobile jack with cushioned hand grip. Jacking system will withstand tons of stress and impact, when locked in place, it stays in place. Welded on foot pads are 4" x 4" and have a Lifetime warranty. Extension - 85" to 114". Weight - 18 lbs.

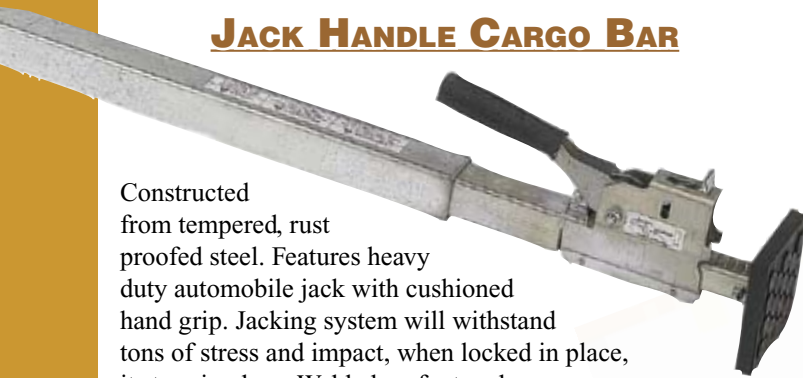

AUTO TRANSIT STRAP WITH CLUSTER HOOK

This is the most popular method now used for transporting autos. This four piece system with different hooks allows you to transport any make of car. Features include rugged two inch polyester webbing with patented ratchet buckle and articulated end fitting which allows strap to move and adjust. Sold in sets of 4 - 8ft. overall length.

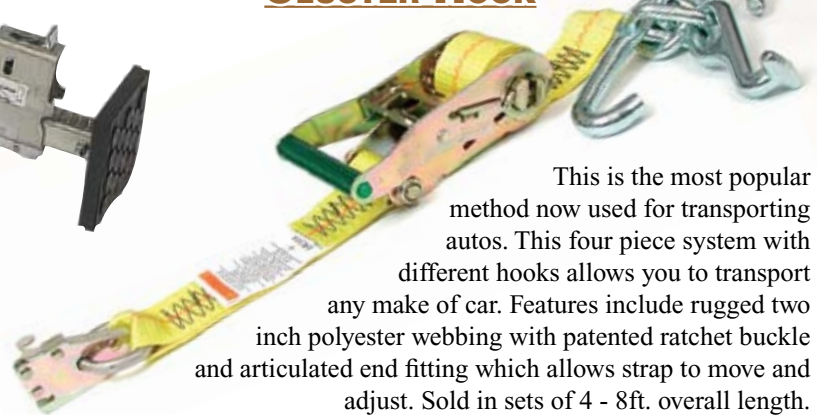

RUBBER FASTENERS



Holds tarps securely in place. Ideal for quickly securing dollies, hand trucks, etc. to van walls. Much faster than rope. Reinforced ends with steel hooks. 9" 15" 21" 31" 41" sizes

HEAVY DUTY RATCHET FLATBED STRAP



Features a wide handle ratchet buckle with 2" webbing. Strap can be positioned on the load for maximum effect, safe and simple to operate. Breaking strength capacity - 10,000 lbs. Length - 27 ft.

ROPE TIE OFF

Quick, convenient way to secure cargo with rope, fits "E" or "A" track, one piece spring end fitting. 3000 lb. rating.



BEAM SOCKETS

Fits series "E" or "A" track for use with standard 2" x 4" or 2" x 6" lumber.



PAN FITTINGS

Designed for low profile mounting in trucks and cargo containers, they are fast and easy to install. Trim plate collar is made of high density polyethylene, the fittings are zinc plated steel. Overall diameter - 4".



RUBBER BAND HOLDER

Organize your rubber bands with this metal holder that fits into your "E" track.



RUBBER BANDS

Heavy duty bands quickly secure pads to furniture and appliances. Helps eliminate need for fitted covers. Approx. slack circumference Small - 50" Medium - 64" Large - 76"



MINI CARGO STRAP

Most versatile cargo strap made. The three-way attachment combination on each end of the strap includes a flat wire hook for securing to edge or lip of trailers, and a "D" ring which can either fasten to a trailer hook or to the flat wire hook to form a wrap around loop. 1" webbing. Breaking strength capacity 3,300 lbs. Length - 16ft.

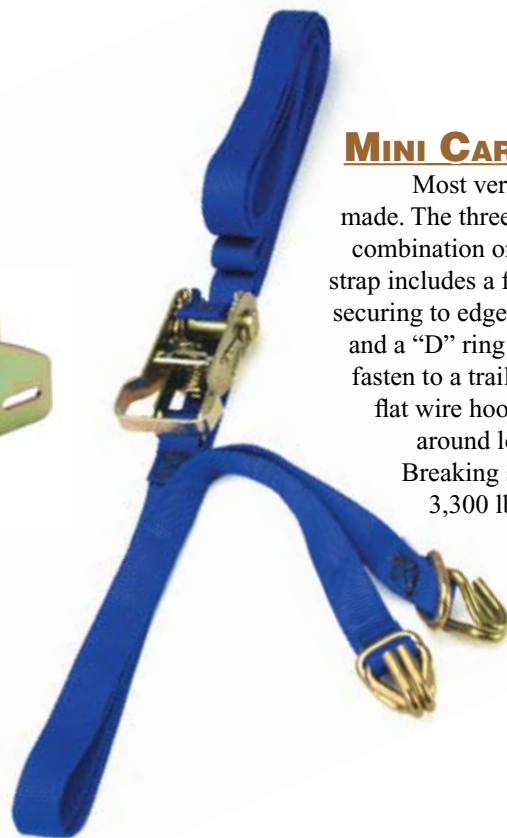

PIANO / APPLIANCE STRAPS

All purpose strap made from heavy duty cotton webbing, has a metal tip with a slide bar roller buckle, commonly used with piano boards and appliance moving. Available in 15 and 20 ft. lengths

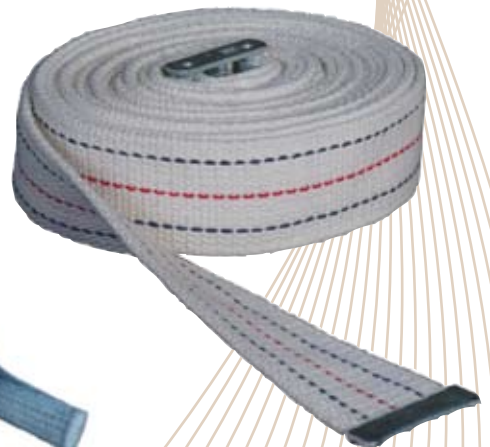

COTTON TIE WEBBING

Useful for many different tie-off applications, strong and non abrasive. Width - 2" Length - 100 ft. roll

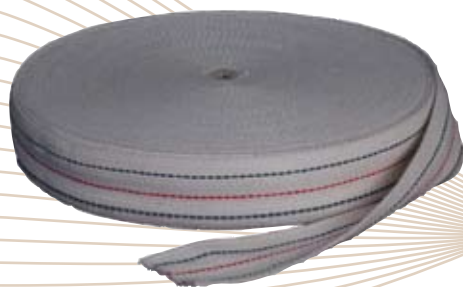

SEWN LOOP WEBBING

Soft 1" tubular nylon webbing with a 5" sewn loop on one end. Length - 15 ft.



HUMP STRAPS

Original style made from soft, sturdy 4 ply burlap for maximum strength. Width - 4" Length - 18 ft.



FURNITURE PADS

MULTICOLOR PAD

- * Strong multicolor material in many different overall patterns and colors
- * Zig zag lock stitching with double stitched reinforced binding on all four sides for strength and durability
- * Heavy cotton filled 30 oz. batting
- * Nylon thread used for extra strength
- * Quilted to prevent tears from spreading
- * This is the most popular pad we sell
- * 72" x 80"
- * Approximate weight - 75 lbs. per dozen



SOLID BLUE/BLEU PAD

- * Dark blue on one side and light blue on the other side in solid colors
- * Presents a uniform appearance
- * Same overall quality construction and materials as the multicolor pad
- * Heavy cotton filled 38 oz. batting
- * 72" x 80"
- * Approximate weight - 79 lbs. per dozen



WAREHOUSE (PALLET) PAD

- * Made of cotton and synthetic materials
- * Cotton filled channel stitch
- * Bound on all sides, double stitch binding
- * Economical pad designed for storage container use
- * Available in two sizes
- * "Warehouse" - 72" x 80"
- Approximate weight - 48 lbs. per dozen
- * "Pallet" - 54" x 72"
- Approximate weight - 35 lbs. per dozen
- * Pallet pads are packed 2 dozen in a bundle



SPACE SAVER FELT PAD

- * Durable 10 oz. burlap on the outside, with a soft moleskin felt in "1" quilt pattern inside
- * Bound and sewn edges all around prevents fraying
- * Ideal for wrapping smaller items or where the bulk of a multicolor pad is not required
- * Available in two sizes
- * 72" x 80" - Approximate weight - 65 lbs. per dozen
- * 54" x 72" - Approximate weight - 50 lbs. per dozen
- * 54" x 72" pads are packed 2 dozen in a bundle



PADDED COVERS

These heavily padded, form fitting, quilted covers offer the best protection for furniture and appliances, solid blue color on both sides.

- * Sofa - 108" x 42" x 42"
- * Chair - 36" x 42" x 42"
- * Loveseat - 60" x 42" x 42"
- * Table top - adjustable with drawstring - 54" x 72"
- * Range/Stove 36" x 42" x 28"
- * Washer/Dryer - 39" x 31" x 26"
- * Refrigerator - Adjustable w/straps - 48" x 68" x 120"
- * Door jamb protector w/3 springs - 72" x 24"



CHAIR COVER



StairKing Battery Powered Stair Climbing Appliance Truck

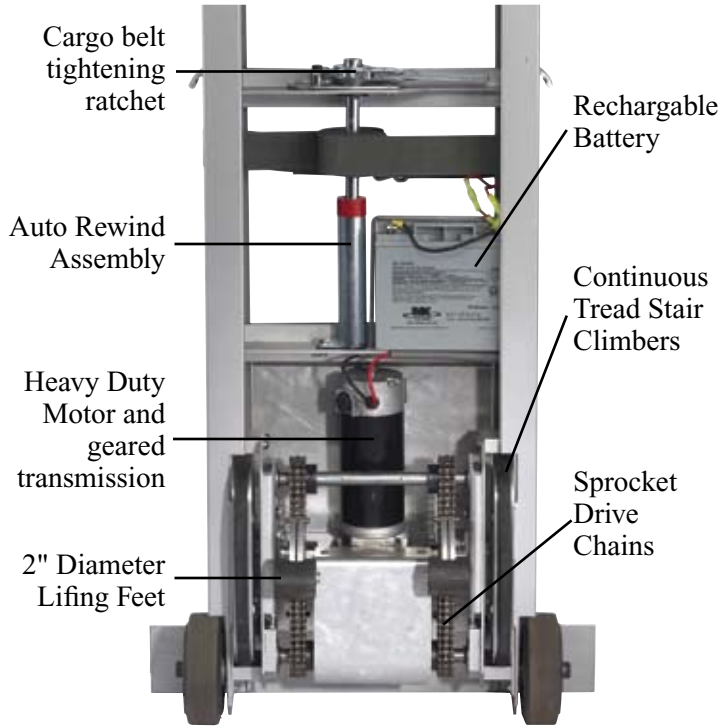

Wesco's state of the art battery powered stair climbing trucks have standard features not available on competitor models.

- * 1/2 horsepower, 50 amp, high torque motor runs cooler under load and gets over 80% more lifts per charge.
- * Industrial grade gear box transmits steady power and is preferable to other drive designs
- * Large 2" diameter, polyurethane lifting feet provide more secure stair gripping
- * Auto rewind ratchet works first to take the slack out of the cargo belt, and then provides a ratchet crank to securely tighten the load
- * Nose plate is 24" wide by 4" deep
- * Sealed maintenance-free battery. Charger and circuit breaker included
- * Welded magnesium frame and noseplate
- * 6" mold-on rubber wheels
- * 30" from noseplate to center of belt

Available in two heights: 66" and 72"

Dimensions

Part #	Model#	Weight	Capacity	Width	Height	Depth
230051	DC-66	101 lbs	850 lbs	19"	66"	15"
230052	DC-72	102 lbs	850 lbs	19"	72"	15"

Superwheel attachment. Installs in seconds. Equipped with 10" x 4" full pneumatic tires. Provides 4 wheel support and eases transport over rough surfaces.

Kick-out wheel Options. Can be ordered with truck or installed later - no drilling necessary. Provides 4 wheel support. Easily deployed with a press of a pedal.



Superwheel Option



Kick out Wheel Option

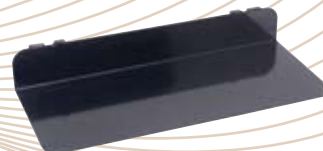
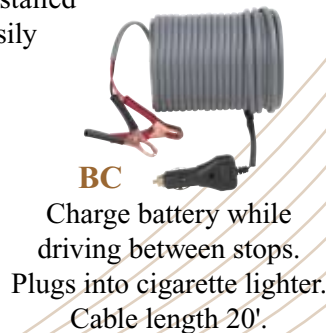

Toe plate extension. Easily clips on to standard toe plate and provides 12" deep x 28" wide cargo surface.

Stevens

APPLIANCE TRUCKS

ALL MODELS SHOWN SHARE THESE FEATURES

- 3-PLY 2 PIECE 14' STRAP • 9 GAUGE - 5" X 24" FOOTPLATE
- RATCHET STRAP TIGHTNER AND AUTOMATIC STRAP RECOIL.
- PADDED WITH NON-MARKING VINYL AND SOFT, PROTECTIVE FELT.
- PATENTED "ESCORT" ROLLER BEARING CRAWLER TREADS
- 6" X 2" CUSHION TREAD RUBBER WHEELS



Stevens "MRT" Series Trucks are constructed from 5" Magnesium "I" Beams. They are the lightest appliance trucks they feature.

MODEL MRT

"SINGLE RATCHET"

- * Height: 60"
- * Width: 17"
- * Weight: 41 lbs.
- * Load Capacity: 500 lbs.

MODEL MRT - 2R

"DOUBLE RATCHETS"

- * Height: 60"
- * Width: 17"
- * Weight: 45 lbs.
- * Load Capacity: 500 lbs.



Stevens "SRT" Series Trucks are constructed from 3/4" X 14 gauge tubular steel. They are the strongest appliance trucks they feature.

MODEL SRT

"SINGLE RATCHET"

- * Height: 60"
- * Width: 16"
- * Weight: 51 lbs.
- * Load Capacity: 750 lbs.

MODEL SRT - 2R

"DOUBLE RATCHETS"

- * Height: 60"
- * Width: 16"
- * Weight: 55 lbs.
- * Load Capacity: 750 lbs.



We repair all models of Stevens Appliance Trucks



MODEL SRT-8

Shares same features of SRT trucks with these exceptions:

- 1" steel tubular frame
- No felt padding on footplate
- 8" x 2-1/2" solid rubber tires for higher ground clearance, rolls easier over gravel and grass

Height: 60"

Width: 16"

Load capacity: 800 lbs.

- Single ratchet
- Weight 48 lbs.

FOOTPLATE ATTACHMENT



Designed to assist in moving big screen TVs. But is adaptable to any oversize load. Fits any Stevens model truck with a 6" wheel, slips easily on and off with no tools. 26" wide x 10" deep



DOUBLE HANDLE MODEL

- Height - 53"
- Width - 14"
- Weight - 32 lbs
- Load Capacity - 600 lbs.

SRT "M" SERIES - KICKOUT WHEELS

MODEL SRT-M-60

Specifications

- Rugged 1" 14 gauge tubular steel construction
- Retractable 3-1/2" swivel casters for supporting load during operation
- The famous Roller Bearing Crawler Treads
- 8" x 2" - 3/4" poly tread/poly core wheels.
- Padded with felt and non-marking vinyl
- Ratchet Strap Tightener
- Automatic Strap Recoil
- 55° Angle with swing released
- One 3-ply 2-piece 14' web strap
- Footplate: 7 Gauge x 5" x 24"
- Load Capacity: 1200 lbs.
- 60" high
- 17" wide
- Weight: 72 lbs.



MODEL SRT-M-72

Specifications

Same as Model SRT-M-60 except this model is 72" high and weighs 77 lbs.

MODEL V-72-M

Specifications

This truck has a specially designed tilt to take tall vending machines beneath low openings or doorways. Truck operates at a 35° angle with swing released and is only 46" high in full recline, otherwise same as model SRT-M-72 only this model weighs 91 lbs.

MODEL SRT-M-66

Specifications

Same as Model SRT-M-60 except this model in 66" high and weighs 74 lbs.

BIG WHEEL ATTACHMENT

You can easily convert your standard Stevens Appliance Trucks to a 10" wheel with the Big Wheel attachment. A 6" x 5/8" turn buckle attaches and removes the wheels easily. Otherwise difficult tasks, like running over sand or gravel, become easy with the Big 10" Wheel Attachment. It also turns your appliance truck into a 4 wheel truck which enables the load to be supported entirely by the truck instead of by the operator.



- Pneumatic 10" Tires
- Weight 15 lbs.
- Model BWA-M fits magnesium trucks
- Model BWA-S fits 3/4" steel trucks

INDUSTRIAL STEEL HANDTRUCKS

Quality American made trucks produced by the same manufacturer in Georgia since 1891.

- Robotic welded joints
- Green epoxy coated paint
- Large 8" x 14" noseplate with raised runners to help slide load off with minimal effort
- Curved crossbars also allows for secure movement of drums or kegs
- Extra long stairclimbers and back lip on noseplate increase frame strength

Equipped with your choice of either 10" 4 ply pneumatic tube tire or 10" balloon cushion tire with poly hub. Both tires have precision sealed ball bearing wheel bearings.



LOOP HANDLE

MODEL

- Height - 50"
- Width - 14"
- Weight - 32 lbs
- Load Capacity - 600 lbs.





AMERICA'S LEADING MANUFACTURER OF HIGH QUALITY ALUMINUM HANDTRUCKS

B & P's Liberation line of handtrucks are the strongest aluminum handtrucks on the market today, check out these features which set them apart from the competition:

1. Frames are made from extruded aluminum which absorbs impact better than competitors' cast aluminum frame, B & P trucks are rated at an actual 600 lb. capacity.
2. Crossbars are complete 4-sided tube with ribbed sidewalls for added strength and attached to the frame with air craft grade rivets, which prevents loosening.
3. Nose plates are constructed of non-cracking, high strength extruded aluminum, axles made from high tensile steel will handle more abuse, and a lifetime warranty on the wheel brackets.
4. Uniquely designed stair climbers made of extruded aluminum make it much less brittle than competitors' cast aluminum stair climbers, B & P wearstrip is 25% more wear resistant and a full 1/2" thick, you can unbolt and reverse the wearstrip for extended life.
5. B & P air tires are a 4-ply rated tube type tire, with a 2-piece hub. These tires are puncture and shock resistant with sealed heavy duty, semi-precision bearings which last longer and keep out dirt and water. Balloon tires are a solid cushion rubber which offer a smooth, shock absorbing roll with a rounded tread for superior mobility.

Upgrade your existing handtruck with genuine B & P parts, they will fit most competitors models. To build your own handtruck choose one component from A+B+C+D and your accessories from E.

A Handle



A1
Standard Loop
50" Overall



A2
Standard Loop
50" Overall
w/U brace



A7
Straight Loop
52" Overall
Vertical Grip
at 52"



A11
Standard Double
Grip 48" Overall
Includes U Brace



A12
Standard Loop
52" Overall
Single grip



A13
Standard Loop
w/Comfort Sleeve
50" Overall

B Frame



B1
Standard
Straight Back



B2
Lattice Back
with 1 strap



B3
Lattice Back
with 2 straps



B4
Curved Back
with 1 strap
All Aluminum



B5
Curved Back
All Aluminum
Beer/Beverage Use



B6
Combination
Back 1 curved/
2 straight



B7
Combination
Back 2 curved/
1 straight

C

Noses



C1
Extruded
Aluminum
14" x 7 1/2"
Recessed Heel



C2
Extruded
Aluminum
18" x 7 1/2"
Recessed Heel
w/cutouts



C14
Extruded
Aluminum
18" x 12"
Front Mount
Solid



C16
Extruded
Aluminum
14" x 7 1/2"
Front Mount
Solid



C17
Extruded
Aluminum
18" x 7 1/2"
Front Mount
Solid



CA1
14" x 7 1/2"
Recessed Heel
w/cutouts
Cast Aluminum



CA2
18" x 7 1/2"
Recessed Heel
w/cutouts
Cast Aluminum

D

Wheels



D2
10" x 2 1/2"
Semi-pneumatic
1 pc. Plastic hub
500 lb. Capacity



D5
10" x 3 1/2"
4-ply pneumatic
2 pc. Steel hub
600 lb. Capacity



D10
10" x 2 1/8"
Balloon Cushion
Polyolefin hub
600 lb. Capacity



D11
8" x 2 1/8"
Balloon Cushion
Polyolefin hub
600 lb. Capacity

E

Accessories



STAIR CLIMBER

Revolutionary, high-strength extruded aluminum stair climber with a 1/2" thick heavy-duty wear strip

E1L - 15" Long

FRAME EXTENSIONS

Heavy-duty formed frame extensions.

Part

- E45 - 45"**
- E52 - 52"**
- E55 - 55"**
- E60 - 60"**
- E68 - 68"**



FOLDING NOSES



Full Channel Extruded
E2F or E2R - 20"
E3F or E3R - 30"

4TH WHEEL ATTACHMENT

Takes the load off the operator. Wheels swivel for maneuverability in tight places. Folds up and out of the way when not in use.

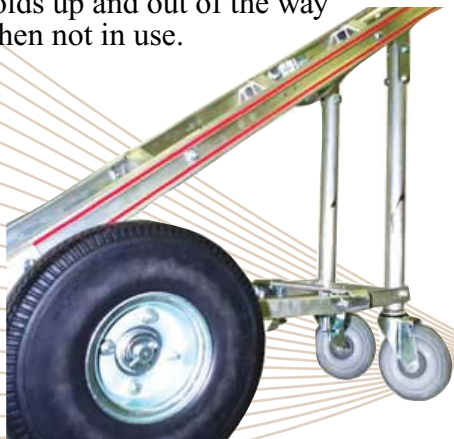

TREAD BRAKES



Finally, a cost effective, lightweight brake system that works. Our design offers a lifetime of service and virtually no maintenance. Modular construction allows for fast, easy replacement of damaged components.

- Custom designed brake always puts equal pressure on both wheels, even in wet conditions.

HERE ARE SOME EXAMPLES OF THE DIFFERENT TYPES OF HANDTRUCKS YOU CAN CREATE. THESE ARE SOME OF OUR MORE POPULAR MODELS:

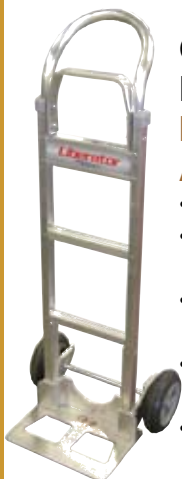

**GENERAL PURPOSE
HANDTRUCK
MODEL
A2-B1-C1-D11**

- 44" load height
- 8" x 2-1/8" Balloon cushion rubber wheels
- Top U brace adds strength and rigidity
- Standard 14" x 7.5" noseplate
- Weight 20 lbs.



**MOVERS HANDTRUCK
MODEL A11-B1-C2-D5-E1L-E52**

- 52" load height
- 10" x 3.5" - 4 ply pneumatic wheels
- Wide 18" x 7.5" noseplate
- Stairclimbers
- Weight 29 lbs.
- **Our most popular model**



**WAREHOUSE
HANDTRUCK
MODEL
A7-B1-C1-D11**

- 52" load height
- 8" x 2-1/8" Balloon cushion rubber wheels
- Standard 14" x 7.5" noseplate
- Weight 22 lbs.



**VERTICAL GRIP
HANDTRUCK
MODEL
A7-B1-C2-D2-E1L**

- 52" load height
- 10" x 2-1/2" semi pneumatic wheels
- Wide 18" x 7.5" noseplate
- Stairclimbers
- Weight 23 lbs.



**BIG NOSE
HANDTRUCK
MODEL
A12-B1-C14-D5**

- 52" load height
- 10" x 3.5" - 4 ply pneumatic wheels
- Extruded aluminum solid noseplate 18" x 12"
- Weight 26 lbs.



**DELIVERY ROUTE
HANDTRUCK
MODEL
A2-B1-C1-D11-E1L**

- 44" load height
- 8" x 2-1/8" Balloon cushion rubber wheels
- Standard 14" x 7.5" noseplate
- Stairclimbers
- Weight 23 lbs.

WE REPAIR B&P AND ALL MANUFACTURERS BRANDS OF ALUMINUM HAND TRUCKS

BEVERAGE HANDTRUCKS



**CLASSIC
BEVERAGE
MODEL
A11-B1-C1-D11-E1L-E52**

- 52" load height
- 8" x 2-1/8" Balloon cushion rubber wheels
- Standard 14" x 7.5" noseplate
- Stairclimbers
- Weight 24 lbs.
- **Our biggest selling beverage truck**



**LOOP HANDLE
BEVERAGE
MODEL
A13-B1-C1-D5-E1L-E52**

- 52" load height
- 10" x 3.5" - 4 ply Pneumatic wheels
- Standard 14" x 7.5" noseplate
- Stairclimbers
- Vinyl covered comfort sleeve handle
- Weight 25 lbs.



**HI-LOAD
BEVERAGE
MODEL
A11-B1-C2-D10-E1L-E60**

- 60" load height
- 10" x 2-1/8" Balloon cushion rubber wheels
- Wide 18" x 7.5" noseplate
- Stairclimbers
- Weight 27 lbs.

b&p ALUMINUM CONVERTIBLE HANDTRUCKS

These convertible handtrucks are built with the same exacting standards as B&P's Liberator handtruck line. These are tough and dependable trucks built for long service and reliability. As a handtruck, they have a 600 lb. capacity, as a platform truck they have a 1200 lb. capacity.



SENIOR

- Loop handle
- 18" x 7 1/2" noseplate
- 10" x 3 1/2" - 4 ply Pneumatic tires
- Locking brake on 1-5" swivel caster
- 600 lb. capacity as handtruck
- 1200 lb. capacity as platform truck

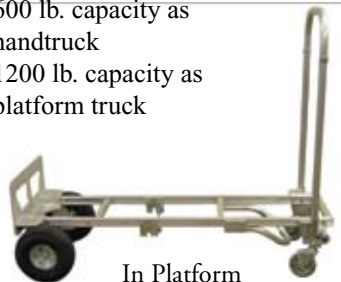

In Platform Truck Position



JUNIOR

- Double grip handle
- 18" x 7 1/2" noseplate
- 10" x 3 1/2" - 4 ply Pneumatic tires
- Locking brake on 1-5" swivel caster
- 600 lb. capacity as handtruck
- 1200 lb. capacity as platform truck

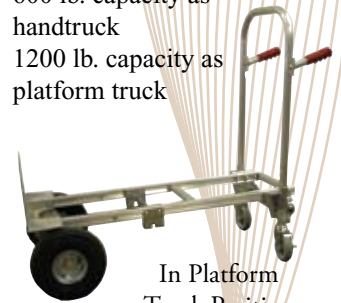

In Platform Truck Position



- One-piece solid release bar
- Simple design—minimal moving parts for maximum reliability
- Smoothest release action in the industry

Specifications	SR	JR
Overall width	20"	20"
Frame width	12"	12"
Overall length (Platform mode)	56"	43"
Height as hand truck	61.5"	52"
Height as platform truck	46"	41"
Platform bed length	51.5"	38.25"
Platform height from floor	11"	11"
Balloon cushion swivel casters	5 x 1.25	5 x 1.25

SNAP-ON DECK

Designed to snap quickly in place and remove easily. The deck helps you carry small tools and oddly-shaped equipment as well as large loads of small packages.



ALUMINUM CURB RAMP

Helps ease the transition of moving your handtruck over curbs, ledges or landings. Much more durable than plastic alternatives. Exclusive process punches holes in the material then raises the edges of the cutouts for superior traction. Lightweight design won't collect ice, mud, snow or debris. Handle slot doubles as a stop.



* Stock Size

Part#	Capacity	W" X L"	Weight
CRP 2618*	750 lbs.	26 x 18	8 lbs.
CRP 2727	750 lbs.	27 x 27	13 lbs.
CRP 2736	750 lbs.	27 x 36	17.5 lbs.
CRP 3030	750 lbs.	30 x 30	15 lbs.
CRP 2745	500 lbs.	27 x 45	22 lbs.

PLASTIC CURB RAMP

Lightweight portable ramp allows for easy movement up and down curbs.

- Weight 7 lbs.
- Capacity 600 lbs.
- Length 23.5"
- Width 21.5"
- Height 6"





PANEL MOVER

Designed principally for moving office partition panels, but flexible uses extend to moving banquet tables, roll goods, mattresses, bedframes, etc. In addition, the panel mover has become a standard in many workrooms for transporting raw materials between workstations.

- Platform: 16 gauge tubular steel and steel plate.
- Overall dimensions: 27 1/2" x 38 1/2".

- Load area: 27 1/2" x 36".
- Two or three removable uprights made of 1" x 16 gauge welded steel tubing - standard, 26" high.
- 11 3/4" between upright sockets.
- Finish: Platform and uprights coated with non-mar, skid-resistant vinyl.
- Load capacity: 2,400 lbs.
- Custom colors available

Item No. Casters

5" Standard Phenolic Casters

3825	5" x 2", Phenolic, 2 fixed, 2 swivel	3 standard
3850	5" x 2", Phenolic, all swivel	3 standard

6" Standard Phenolic Casters

3826	6" x 2", Phenolic, 2 fixed, 2 swivel	3 standard
3860	6" x 2", Phenolic, all swivel	3 standard

5" Quiet Poly Casters

3851	5" x 2", Quiet Poly, 2 fixed, 2 swivel	3 standard
3852	5" x 2", Quiet Poly, all swivel	3 standard

8" Quiet Poly Casters

3828	8" x 2", Quiet Poly, 2 fixed, 2 swivel	3 standard
3880	8" x 2", Quiet Poly, all swivel	3 standard

Uprights

Item No. Casters

5" Standard Phenolic Casters

3865	5" x 2", Phenolic, 2 fixed, 2 swivel	2 standard
3867	5" x 2", Phenolic, all swivel	2 standard

6" Standard Phenolic Casters

3866	6" x 2", Phenolic, 2 fixed, 2 swivel	2 standard
3868	6" x 2", Phenolic, all swivel	2 standard

5" Quiet Poly Casters

3872	5" x 2", Quiet Poly, 2 fixed, 2 swivel	2 standard
3871	5" x 2", Quiet Poly, all swivel	2 standard

8" Quiet Poly Casters

3843	8" x 2", Quiet Poly, 2 fixed, 2 swivel	2 standard
3882	8" x 2", Quiet Poly, all swivel	2 standard

Uprights



PANEL MOVER WITH EXTRA TALL UPRIGHTS

Our panel mover was originally designed for moving office partition panels, but by adding extra tall uprights, the uses become endless.

- Platform: 16 gauge tubular steel and steel plate.
- Overall dimensions: 27 1/2" x 38 1/2".
- Load area: 27 1/2" x 36".

- Two or three removable uprights made of 1" x 14 gauge welded steel tubing - Extra Tall, 45" high.
- Finish: Platform and uprights coated with non-mar, skid-resistant vinyl.
- Load capacity: 2,400 lbs.
- Custom colors available

Item No. Casters

5" Standard Phenolic Casters

3845	5" x 2", Phenolic, 2 fixed, 2 swivel	3 extra tall
3847	5" x 2", Phenolic, all swivel	3 extra tall

6" Standard Phenolic Casters

3846	6" x 2", Phenolic, 2 fixed, 2 swivel	3 extra tall
3848	6" x 2", Phenolic, all swivel	3 extra tall

5" Quiet Poly Casters

3853	5" x 2", Quiet Poly, 2 fixed, 2 swivel	3 extra tall
3854	5" x 2", Quiet Poly, all swivel	3 extra tall

8" Quiet Poly Casters

3829	8" x 2", Quiet Poly, 2 fixed, 2 swivel	3 extra tall
3881	8" x 2", Quiet Poly, all swivel	3 extra tall

Uprights

Item No. Casters

5" Standard Phenolic Casters

3855	5" x 2", Phenolic, 2 fixed, 2 swivel	2 extra tall
3857	5" x 2", Phenolic, all swivel	2 extra tall

6" Standard Phenolic Casters

3856	6" x 2", Phenolic, 2 fixed, 2 swivel	2 extra tall
3858	6" x 2", Phenolic, all swivel	2 extra tall

5" Quiet Poly Casters

3861	5" x 2", Quiet Poly, 2 fixed, 2 swivel	2 extra tall
3863	5" x 2", Quiet Poly, all swivel	2 extra tall

8" Quiet Poly Casters

3884	8" x 2", Quiet Poly, 2 fixed, 2 swivel	2 extra tall
3885	8" x 2", Quiet Poly, all swivel	2 extra tall

Uprights

MIGHTY KING: THE ORIGINAL DESK LIFT

Engineered for easy moving of most types of office desks by just one person. Reduces labor and moving costs; saves time and effort too. No need to empty drawers or remove equipment and material from desk tops. Simply roll Mighty King desk lift beneath desk, depress handle and elevate desk. In seconds desk can be rolled in any direction. All Mighty King desk lifts are manufactured and assembled in the USA under rigid quality control standards with these special design features:

- * Sturdy roller-bearing, non-mar hard rubber casters rotate freely in a 360 degree circle for easy maneuvering.
- * Handle is removable. Safety latch automatically locks in raised position with a convenient trip for release.
- * Heavy duty casting and steel caster base, powder coated finish.
- * Lift frame is coated with a tough non-mar, skid-resistant red vinyl.
- * Shipped fully assembled in one carton.



Model 2000 - 2 1/2" Casters

- * Load capacity: 600 lbs.
- * Lowered position: 4 1/4".
- * Raised position: 9 3/4".
- * Overall dimensions: 22" x 32".
- * Lift frame: 16" x 32".
- * Casters: 2 1/2" dia. x 1 1/8"
- * Shipping weight: 44 lbs. UPS.

Model 2000-40

- Same as Model 2000 except:
- * Lift frame: 16" x 40".
 - * Shipping weight: 48 lbs. UPS.

Model 2000-46

- Same as Model 2000 except:
- * Lift frame: 16" x 46".
 - * Shipping weight: 49 lbs. UPS.

Model 2300 - 3" Casters

- Same as Model 2000 except:
- * 40" lift frame.
 - * Lowered position: 4 3/4".
 - * Raised position: 10 1/4".
 - * Lift frame: 16" x 32".
 - * Casters: 3" dia. x 1 1/4"
 - * Shipping weight: 45 lbs. UPS.

KARRY KING FILE DOLLY

Unique design allows lever action to lift your load while counter-balance prevents it from tipping. Easy operation is a time and backsaver when moving file cabinets, appliances, drums, crates or cartons. Non-skid, bonded vinyl finish protects your load. Two non-marring 3" wheels. Two 2 1/2" full swivel non-marring hard rubber casters for ease in moving any load in any direction.



Model 3218

- * Load capacity: 600 lbs.
- * Legal size: 18" x 32".
- * Packed one per carton.
- * Shipping weight: 23 lbs. UPS.

Model 3220

- Same as Model 3218 but with a frame size of 20" x 32".
- * Packed one per carton.
 - * Shipping weight: 27 lbs. UPS.

Model 3215

- * Load capacity: 600 lbs.
- * Letter size: 15" x 32".
- * Packed one per carton.
- * Shipping weight: 21 lbs. UPS.

Model 2300-40

- Same as Model 2300 except:
- * Lift frame: 16" x 40".
 - * Shipping weight: 50 lbs. UPS.

Model 2300-46

- Same as Model 2300 except:
- * Lift frame: 16" x 46".
 - * Shipping weight: 51 lbs. UPS.

Model 3500 - 3 1/2" Casters

- * 46" lift frame.
- * Load capacity: 600 lbs.
- * Lowered position: 5 1/2".
- * Raised position: 10 3/4".
- * Lift frame: 16" x 32".
- * Casters: 3 1/2" dia. x 1 5/16"
- * Shipping weight: 48 lbs. UPS.

Model 3500-40

- Same as Model 3500 except:
- * Lift frame: 16" x 40".
 - * Shipping weight: 51 lbs. UPS.

Model 3500-46

- Same as Model 3500 except:
- * Lift frame: 16" x 46".
 - * Shipping weight: 52 lbs. UPS.

4000 Series - 4" Casters

- Same as Model 3500 except:
- * Lowered position: 6".
 - * Raised position: 11 1/4".
 - * Lift frame: 16" x 32".
 - * Casters: 4" dia. x 1 5/16"
 - * Shipping weight: 49 lbs. UPS.

Model 4000-40

- Same as Model 4000 except:
- * Lift frame: 16" x 40".
 - * Shipping weight: 52 lbs. UPS.

Model 4000-46

- Same as Model 4000 except:
- * Lift frame: 16" x 46".
 - * Shipping weight: 53 lbs. UPS.

SINGLE PEDESTAL ATTACHMENT DESK MOVER

Attaches to all Mighty King Desk Lifts in seconds for lifting either right or left handed pedestal desks. Unit acts as substitute pedestal



and distributes weight evenly. Adjustable support adapts to any height with thumb screws securing proper height. Constructed of heavy gauge electric welded steel tubing. Powder coated finish. Support is coated with non-skid, non-marring bonded vinyl.

Model 1800

- * Load capacity: 250 lbs.
- * Overall dimension: 18" x 18".
- * Packed one per carton.
- * Product weight: 13 lbs.
- * Shipping weight: 30 lbs. UPS (oversize.)

ROL-A-LIFT

is the practical method of moving bulky and hard-to-handle loads. Rol-A-Lifts are ideal for handling large, awkward objects or

heavy equipment that is difficult to maneuver or position, like refrigerator cases, safes, or machines. Yet they are versatile enough to safely handle fragile, sensitive equipment, like glass crates, computers, electrical panels and switchgear.

Options

Polyurethane wheels offer superior floor protection

- * Single polyurethane wheels
- * Dual polyurethane wheels



**Model
M-4**

	M-2	M-4	M-4-6	M-6	M-8	M-10	M-12
Capacity Per Pair	2,000#	4,000#	4,000/6,000#	6,000#	8,000#	10,000#	12,000#
Max. Hydraulic Lift	5-1/8"	12"	12" / 6"	6"	6"	6"	6"
Type of Lift	Hydraulic	Hydraulic	Hydraulic	Hydraulic	Hydraulic	Hydraulic	Hydraulic
Standard Wheels	Phenolic	Phenolic	Phenolic	Phenolic	Steel	Steel	Forged-Steel
Wheel Size	5" x 2"	6" x 2"	6" x 2"	6" x 2"	8" x 2-1/2"	8" x 3"	8" x 2-1/2"
Overall Height	47-1/2"	44"	44"	42-1/2"	45"	45-1/2"	45-1/2"
Overall Width	22"	23"	23"	23"	23-1/8"	24"	24"
Caster Centers	18"	18"	18"	18"	18"	18"	18"
Overall Depth	12-1/2"	16-1/2"	16-3/4"	16-3/4"	17-1/4"	18"	18"
Forks Adjustable	7-1/4"-17-1/2"	5"-19-1/2"	6"-19-1/2"	6"-19-1/2"	7-1/4"-19-1/2"	9-1/4"-19-1/2"	9-1/4"-19-1/2"
Fork Length	5"	6"	6"	6"	6"	6"	6"
Fork Thickness	3/4"	1-1/8"	1-1/8"	1-1/8"	1-1/8"	1-1/8"	1-1/8"
Weight	160#	325#	340#	335#	400#	438#	470#

• Compression molded, fiber-filled, hard resin wheels provide easy rolling and floor protection.

FURNITURE MOVERS

Move a variety of items such as crates, coolers, vending machines, appliances as well as furniture with these lightweight, compact movers. These hydraulic operated units are sold in pairs and feature a built on ratchet strap system which wraps around the load to hold it securely.

16' long strap

- * Lift Height - 10"
- * Weight - 190 lbs. (Pair)
- * Lift Plate - 23" long X 2 1/4" deep
- * Width - 26 1/2"
- * Depth - 16"
- * Height - 42"
- * Load Capacity - 3950 lbs. (Pair)



Features

6" Moldon Polyurethane Casters

STRETCH FILM

High quality film which offers superior strength, puncture resistance and cling. Clear 80 gauge packed 4 rolls per case, 18" x 1500 ft. rolls.

5" WIDE BANDING STRETCH FILM

Ideal for all types of jobs big or small, holds odd shaped materials together, will not damage surfaces, saves time and money, less expensive than tape or twine, each roll has its own extended core handle. Clear 80 gauge film packed 15 rolls per case, 5" x 1000 ft. rolls.

ROLLER DISC DISPENSERS (PICTURED)

Inexpensive plastic inserts allow for easy dispensing of film, tough and reusable.



TAPE

Heavy duty poly tape is the most widely used style of tape in the Moving & Storage industry, perfect for all packaging applications. 2" x 55 YD. rolls - 36 rolls per case.

TAPE DISPENSER

Traditional pistol grip handle style with built in static roller that holds tape in place while dispensing. Handles 2" wide rolls.

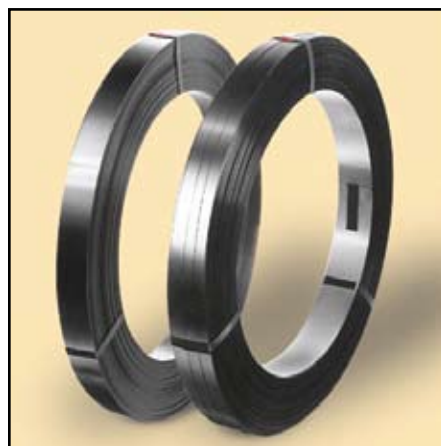

STEEL STRAPPING

Prime steel strapping that is black painted, waxed, and deburred for smooth handling and easy workability in tools.

Average Coil Weight 100 lbs.

STRAPPING SIZE	AVG. BREAKING STRENGTH LBS.	FEET/POUND
1/2 x .020	1220	29.4
5/8 x .020	1500	23.6
3/4 x .020	1810	19.6

STEEL SEALS

Available for 1/2", 5/8", or 3/4" strapping open seal design - 5000 seals per box.

SEALER



A simple and reliable design. Front action, double notch, down-cut seal. For use with standard duty seals and strapping. Premium quality made tool, specify 1/2", 5/8" or 3/4".

TENSIONER



Premium quality made tool, trouble free feed wheel type design. Tensioner designed for use with 3/8" to 3/4" strapping.

MOBILE DISPENSER



Features include heavy duty steel frame, large tool and seal tray, 10" semi-pneumatic wheels, automatic coil brake and heavy gauge steel discs with single locking nut for easy coil loading. Unit is 24" wide and is very stable on rough surfaces.

HEVI MOVER™ MACHINE ROLLERS

FEATURES:

- Swivel-top for maximum maneuverability, full 360° rotation.
- Spring-loaded locking mechanism at -45° intervals.
- Only periodic cleaning and light re-oiling of roller chain needed.



HeviMovers™ are made with precision ground and hardened steel rollers that form an endless chain which revolves around a central load-bearing plate in the frame. Weight of the load is transferred directly from load-bearing plate to rollers. This eliminates axle friction and requires less power to start and move the load. HeviMovers™ roll easily over cracks and pitted floor areas to reduce possible damage to goods.

Part # Model #	480001 HMS-2	480002 HMS-8	480003 HMS-15	480004 HMS-30
Body (H x W X L)	3.1875" x 3.125" x 8"	4.4375" x 5.5" x 10"	4.875" x 5.75" x 10.5"	4.875" x 6.5" x 12.75"
Roll Width	1.875"	3.25"	3.25"	4"
Roll Diameter	.6875"	.9375"	1.1875"	1.1875"
Capacity (each)	2,000 lbs.	8,000 lbs.	15,000 lbs.	30,000 lbs.
Weight	10 lbs.	31 lbs.	39 lbs.	52 lbs.

HEVI MOVER™ OPTIONS

- Steering handles • Turning bar

FURNITURE SKATES



Ideal for use under panel systems, partitions, and for sliding your heaviest furniture effortlessly. Skates are a 5" diameter circle constructed of hard plastic with soft rubber cushion top.

PIANO BOARD



Solid hardwood construction. Deckboard is padded and upholstered with heavy duty canvas. Comes standard with 6 "E" track attachments. 6 foot overall length.

CPII PALLET TRUCK

This truck represents the best combination of price and quality that we tested, comes with polyurethane wheels which roll easier, wear better and last longer than standard nylon wheels, also overload bypass with 3 year pump warranty.

2 Sizes Available:
 27" wide x 48" long Raised height: 8"
 21" wide x 48" long Lowered height: 3"
 Lift height: 5"

The rugged CPII includes the following standard features:

- Adjustable fork connecting rods
- Entry / Exit rollers
- Reinforced forks
- Rubber coated handle
- 3 position hand control
- Spring loaded safety handle design
- Weight: 202 lbs.

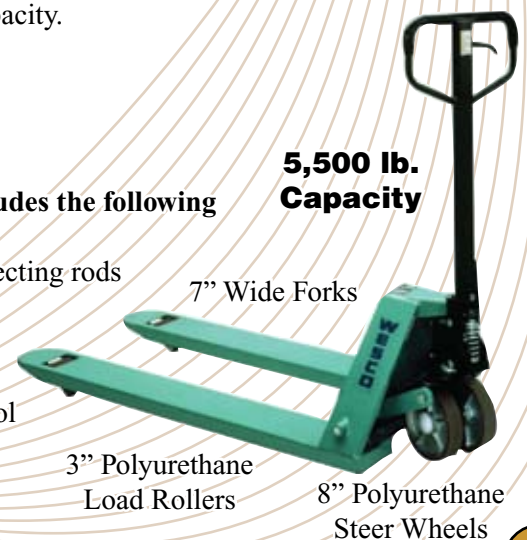

**5,500 lb.
Capacity**

7" Wide Forks

3" Polyurethane
Load Rollers

8" Polyurethane
Steer Wheels

FOREARM FORKLIFT



- Each set has a pair of adjustable straps 9 feet 4 inches long.
- For items up to 600 lbs.
- Instructions included

PALLET PULLER



Rugged cast iron pullers access loads beyond fork lift reach. A positive locking grip is exerted onto the pallet. It locks tighter the harder you pull. Automatic release. 4000 lb. capacity.

ALUMINUM PLATFORM TRUCKS



- Lightweight aluminum construction - easy to handle
- Features heavy duty understructure with side rails that lock into the deck for extra strength
- Truck comes complete with removable handle and 2 rigid and 2 swivel casters
- With 6" caster - 1500 lb. capacity
- With 8" caster - 2000 lb. capacity

(Tread Plate Deck pictured here)

Available with tread plate or smooth plate decks



All trucks are equipped with soft rubber TPR non-marking casters — The best high performance caster available

- Easier, more responsive starts and rolling than mold on rubber
- Resists and rejects metal shavings, chips and other debris
- Impact resistant with maximum shock absorption

TREADPLATE DECK	6" CASTER	8" CASTER
Deck Size W x L	Model #	Model #
24" x 36"	PT-2436T-150-650	PT-2436T-150-850
24" x 48"	PT-2448T-150-650	PT-2448T-150-850
24" x 60"	PT-2460T-150-650	PT-2460T-150-850
30" x 48"	PT-3048T-150-650	PT-3048T-150-850
30" x 60"	PT-3060T-150-650	PT-3060T-150-850
30" x 72"	PT-3072T-150-650	PT-3072T-150-850
36" x 48"	PT-3648T-150-650	PT-3648T-150-850
36" x 60"	PT-3660T-150-650	PT-3660T-150-850
36" x 72"	PT-3672T-150-650	PT-3672T-150-850

SMOOTH PLATE DECK	6" CASTER	8" CASTER
Deck Size W x L	Model #	Model #
24" x 36"	PT-2436S-150-650	PT-2436S-150-850
24" x 48"	PT-2448S-150-650	PT-2448S-150-850
24" x 60"	PT-2460S-150-650	PT-2460S-150-850
30" x 48"	PT-3048S-150-650	PT-3048S-150-850
30" x 60"	PT-3060S-150-650	PT-3060S-150-850
30" x 72"	PT-3072S-150-650	PT-3072S-150-850
36" x 48"	PT-3648S-150-650	PT-3648S-150-850
36" x 60"	PT-3660S-150-650	PT-3660S-150-850
36" x 72"	PT-3672S-150-650	PT-3672S-150-850

WOODEN PLATFORM TRUCK



Wood deck platform trucks are widely used, easy to operate, economical and built to last. Decks are 1" sanded hardwood with a natural finish. Comes standard with one removable handle. Equipped with two rigid and two swivel 6" rubber on steel casters. 1640 lb. capacity.

Model PT24 - 24" x 48" Deck Model PT 30 - 30" x 60" Deck

J BARS



- One piece full length hardwood handle provides maximum strength.
 - Formed steel nose plate with bevel on bottom side of nose prevents loads from slipping off.
 - Equipped with 5" x 1-1/2" steel or rubber wheels.
- 5 ft. handle - 3200 lb. capacity
6 ft. handle - 4250 lb. capacity
7 ft. handle - 5000 lb. capacity

HEAVY DUTY PANEL / SHEET MOVER

Rugged construction assures years of superior performance from this maximum-duty truck. Ideal for transporting sheetrock, building materials, office partition panels, furniture, TVs, luggage and other heavy loads.

- Platform Base: 12-gauge steel base reinforced with 12-gauge steel ribs for lasting durability.
- Platform is coated with anti-skid polyvinyl to help secure and protect the load.
- Push handle or heavy-duty uprights equipped with two cross-braces for maximum strength and to keep small parcels in place, uprights are 26" tall.
- Load capacity: 3200 lbs.
- Dimensions: 30" x 54" overall; 11 1/2" floor to top of base; 37 1/2" high; 8 1/2" between upright sockets.
- Packed one per carton.
- Shipped KD by truck.



ITEM NO.	CASTERS	CAPACITY	UPRIGHTS	WEIGHT
8" Quiet Poly Casters				
3901	8" x 2", Quiet Poly, 2 fixed, 2 swivel	3200 lbs.	2 standard	150 lbs.*
3908	8" x 2", Quiet Poly, all swivel	3200 lbs.	2 standard	150 lbs.*
3911	8" x 2", Quiet Poly, 2 fixed, 2 swivel	3200 lbs.	4 standard	167 lbs.*
3918	8" x 2", Quiet Poly, all swivel	3200 lbs.	4 standard	169 lbs.*

Masonite

High density tempered Brazilian Masonite 1/4" thick - 32" x 48" sheets



"A" FRAME DOLLY

- Transport masonite or plywood on edge
- 30" x 42" steel frame
- Steel "A" frame stands 48" above deck
- 2 pieces of logistic track welded to the bottom
- Equipped with 12 ft. spring end strap
- 6" Phenolic swivel casters
- 2000 lb. weight capacity

DESK RISER BOX



Fits snugly on top of a dolly. Boxes design and 3/4" plywood construction make it strong and durable. Box is assembled and glued with all edges fully carpeted. Fits carpeted or rubber end dolly - please specify.

Size - 18" x 30" Height - 6-1/2"

Tow Hook



Zinc plated steel with a tapered tip, hooking it under a dolly allows you a forward, upward pressure, helpful in moving and steering a dolly under load. Vinyl coated handle. Length: 34" Weight: 2 lbs.



FIBERGLASS RAMPS

These ramps are formed from one solid piece of molded re-inforced fiberglass. This innovative design provides a high strength to weight ratio. The heavy duty aluminum end plate is beveled to a perfect taper at ground level for stable, slip free loading. A self storing ball locking pin secures the truck end. Melchers rock hard Agra-Grip surface coating is permanently imbedded in the ramps deck. For non slip traction in wet or dry weather. If after years of service the coating ever wears down, you can easily resurface your ramp with a simple, inexpensive surface compound kit. The two-in-one auto loader ramp is the most popular ramp with movers nationwide because it can be separated into two 18" halves for loading autos, you can then join the two halves together to form a solid 36" wide walk board for loading household goods.



AUTO LOADER RAMPS

Model	Length	Width	Capacity	Ramp Wt.	Working Ht.
636 AL	6 ft.	36"	4,000 lbs.	75 lbs.	12 - 18"
7530 AL	7 1/2 ft.	30"	4,000 lbs.	75 lbs.	13 - 22"
836 AL	8 ft.	36"	4,000 lbs.	95 lbs.	16 - 24"
1036 AL	10 ft.	36"	5,000 lbs.	135 lbs.	20 - 30"
1236 AL	12 ft.	36"	5,000 lbs.	155 lbs.	26 - 35"
1436 AL	14 ft.	36"	5,000 lbs.	175 lbs.	30 - 45"
1636 AL	16 ft.	36"	5,000 lbs.	220 lbs.	34 - 50"

REPLACEMENT AUTO LOADER HALVES

1018 AL	10 ft.	18"	2,500 lbs.	70 lbs.	20 - 30"
1218 AL	12 ft.	18"	2,500 lbs.	78 lbs.	26 - 35"
1418 AL	14 ft.	18"	2,500 lbs.	88 lbs.	30 - 45"
1618 AL	16 ft.	18"	2,500 lbs.	110 lbs.	34 - 50"

(Male Hinge Pin - Right side facing the rear of truck • Female Hinge - Left)

HEAVY DUTY SINGLE RAMPS

Model	Length	Width	Capacity	Ramp Wt.	Working Ht.
7530	7 - 1/2 ft.	30"	3,000 lbs.	75 lbs.	13 - 22"
1030	10 ft.	30"	3,000 lbs.	103 lbs.	20 - 30"
1230	12 ft.	30"	3,000 lbs.	134 lbs.	26 - 35"
1430	14 ft.	30"	3,000 lbs.	145 lbs.	30 - 45"
636	6 ft.	36"	3,000 lbs.	75 lbs.	12 - 18"
836	8 ft.	36"	3,000 lbs.	95 lbs.	16 - 24"
1036	10 ft.	36"	3,000 lbs.	130 lbs.	20 - 30"
1236	12 ft.	36"	3,000 lbs.	150 lbs.	26 - 35"
1436	14 ft.	36"	3,000 lbs.	170 lbs.	30 - 45"

LIGHTER DUTY SINGLE RAMPS

Model	Length	Width	Capacity	Ramp Wt.	Working Ht.
726	7 ft.	26"	1,500 lbs.	50 lbs.	12 - 28"
7526	7 - 1/2 ft.	26"	1,500 lbs.	55 lbs.	12 - 30"
1026	10 ft.	26"	1,500 lbs.	84 lbs.	16 - 38"
1029	10 ft.	29"	1,500 lbs.	95 lbs.	16 - 38"
1032	10 ft.	32"	1,500 lbs.	108 lbs.	16 - 38"
1222	12 ft.	22"	1,500 lbs.	95 lbs.	18 - 46"
1226	12 ft.	26"	1,500 lbs.	98 lbs.	18 - 46"
1229	12 ft.	29"	1,500 lbs.	110 lbs.	18 - 46"
1426	14 ft.	26"	1,500 lbs.	116 lbs.	20 - 54"



ALUMINUM VAN RAMP

Maintenance free ramps offer safe, smooth ground to van access.



Ramps have raised curbs which provide a full length hand grip and will deter runoffs.

Light weight ramp with extruded "I" beam understructure for maximum strength prevents sagging under capacity loads. "Sure-Trac" ribbed aluminum decks are welded to the extruded aluminum curb-gives you positive traction in all kinds of weather. All aluminum construction eliminates maintenance problems; rust proof, corrosion proof, won't splinter or crack. All ramps have a smooth apron at truck end and a sloped lip at the ground. Available in Standard or Heavy Duty models.

The usable width of the ramps are 2" less than the overall width.

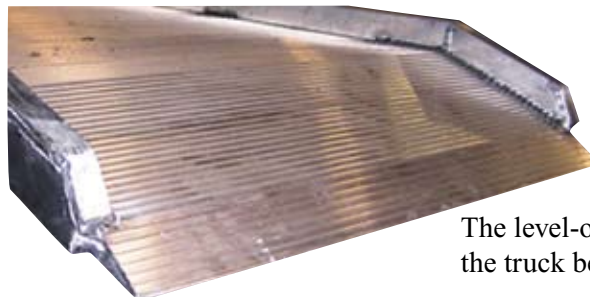

The level-off apron overlaps the truck bed.

STANDARD DUTY RAMP

28" Wide Ramps (26" Usable)

MODEL	RAMP LENGTH	RAMP WEIGHT	CAPACITY
PR-2806-A	6"	48 lbs.	2,000 lbs.
PR-2807-A	7"	56 lbs.	1,800 lbs.
PR-2808-A	8"	63 lbs.	1,800 lbs.
PR-2809-A	9"	70 lbs.	1,650 lbs.
PR-2810-A	10"	77 lbs.	1,500 lbs.
PR-2812-A	12"	92 lbs.	1,400 lbs.
PR-2814-A	14"	107 lbs.	1,200 lbs.
PR-2816-A	16"	121 lbs.	1,000 lbs.

HEAVY DUTY RAMP

MODEL	RAMP LENGTH	RAMP WEIGHT	CAPACITY
XA40-38-06	6'	97 lbs.	4,000 lbs.
XA40-38-08	8'	129 lbs.	4,000 lbs.
XA40-38-10	10"	161 lbs.	4,000 lbs.
XA40-38-12	12'	194 lbs.	4,000 lbs.
XA35-38-14	14'	226 lbs.	3,500 lbs.
XA30-38-16	16'	258 lbs.	3,000 lbs.

38" Wide Ramps (36" Usable)

MODEL	RAMP LENGTH	RAMP WEIGHT	CAPACITY
PR-3806-A	6"	61 lbs.	2,000 lbs.
PR-3807-A	7"	70 lbs.	1,800 lbs.
PR-3808-A	8"	79 lbs.	1,600 lbs.
PR-3809-A	9"	88 lbs.	1,650 lbs.
PR-3810-A	10"	97 lbs.	1,500 lbs.
PR-3812-A	12"	115 lbs.	1,400 lbs.
PR-3814-A	14"	133 lbs.	1,200 lbs.
PR-3816-A	16"	151 lbs.	1,000 lbs.

44" Wide Ramps (42" Usable)

MODEL	RAMP LENGTH	RAMP WEIGHT	CAPACITY
XA25-44-06	6'	109 lbs.	2,500 lbs.
XA25-44-08	8'	144 lbs.	2,500 lbs.
XA25-44-10	10"	180 lbs.	2,500 lbs.
XA25-44-12	12'	217 lbs.	2,500 lbs.
XA25-44-14	14'	253 lbs.	2,500 lbs.
XA25-44-16	16'	289 lbs.	2,500 lbs.

ALUMINUM DOCKBOARDS WITH WELDED ALUMINUM CURBS

- Up to 17,000 pound capacity
- More durable aluminum construction
- Complete perimeter weld for aluminum curbs
- Will outlast competitor's steel curbed models
- Skid Resistant Surface
- Bolt on legs for quick field repair

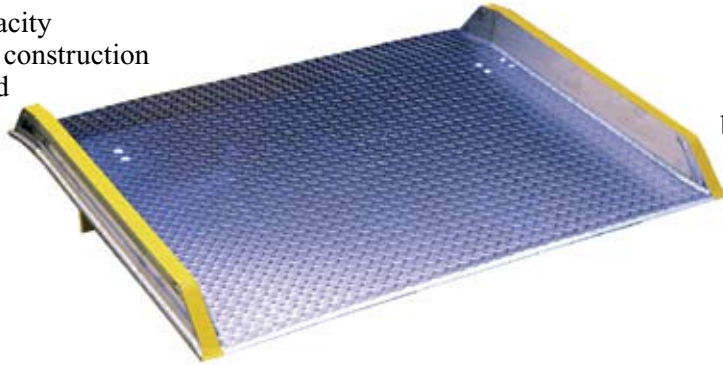

LIFTING CHAINS

Heavy-duty chains for fork-lift moving of dockboards. Quickly and easily attached onto the dockboard curbs with heavy-duty steel hooks. (Recommended for boards 10,000 lbs. capacity and up)

ALUMINUM DOCK BOARDS are essential for loading and unloading anything between a truck and a dock. Our high strength aluminum welded on curbs preserve the life of the dockboard and keep the board lightweight. We don't use steel bolt-on curbs because of the characteristics of aluminum itself. As the forklift moves over the dockboard, the base flexes. With steel curbs, that don't flex, the attachment bolts become loosened as the connections get bigger with the flex of the base. Having aluminum curbs fully welded onto the deck allows the dockboard to flex with the weight and makes sure the forklift stays on track. This curb design adds to the strength and durability of the dockboard and actually reduces the overall weight.

Made from high strength aluminum, our dockboards can handle up to 17,000 pounds. This means that the entire load can be on the dockboard at once. Our actual capacities differ from some competitors as they assume only two wheels of the load will be on the dockboard at once. We've gone through our testing assuming the entire load will need to be sustained, therefore including an extra margin for safety.

5,000-7,000 LB CAPACITY

5/16" aluminum 3" welded curb

Size (W x L)	Max Ht. Diff (In)	Leg (In)	Cap (Lbs)	Part #	Wt (Lbs)
48x36	5	7	7000	L7-4836	80
48x48	7	9	7000	L7-4848	107
48x60	10	12	7000	L7-4860	133
60x36	5	7	7000	L7-6036	93
60x48	7	9	7000	L7-6048	124
60x60	10	12	7000	L7-6060	155
60x72	12	18	5000	L5-6072	193
72x36	5	7	5000	L5-7236	106
72x48	7	9	5000	L5-7248	141
72x60	10	12	5000	L5-7260	177

10,000 LB CAPACITY

3/8" aluminum 3.5" welded curb

Size (W x L)	Max Ht. Diff (In)	Leg (In)	Cap (Lbs)	Part #	Wt (Lbs)
48x36	5	7	10000	L10-4836	97
48x48	7	9	10000	L10-4848	130
48x60	10	12	10000	L10-4860	162
60x36	5	7	10000	L10-6036	113
60x48	7	9	10000	L10-6048	151
60x60	10	12	10000	L10-6060	188

12,000-14,000 LB CAPACITY

3/8" aluminum 4" welded curb

Size (W x L)	Max Ht. Diff (In)	Leg (In)	Cap (Lbs)	Part #	Wt (Lbs)
60x36	5	7	14000	L14-6036	120
60x48	7	9	14000	L14-6048	160
60x60	10	12	14000	L14-6060	200
60x72	12	18	12000	L12-6072	248
72x36	5	7	12000	L12-7236	136
72x48	7	9	12000	L12-7248	181
72x60	10	12	12000	L12-7260	226

15,000-17,000 LB CAPACITY

1/2" aluminum 4" welded curb

Size (W x L)	Max Ht. Diff (In)	Leg (In)	Cap (Lbs)	Part #	Wt (Lbs)
60x36	5	7	17000	L17-6036	146
60x48	7	9	17000	L17-6048	195
60x60	10	12	17000	L17-6060	244
60x72	12	18	15000	L15-6072	300
72x36	5	7	15000	L15-7236	167
72x48	7	9	15000	L15-7248	223
72x60	10	12	15000	L15-7260	279
72x72	12	18	12000	L12-7272	342

ALUMINUM DOCKPLATES

- Easy lifting handles
- High traction safety treadplate
- Bolted legs for easy repair
- Beveled edges for a smooth transition
- Engineered bend to keep the dock plate flush with truck
- Actual Capacity rated
- Up to 10,000 lb. capacity

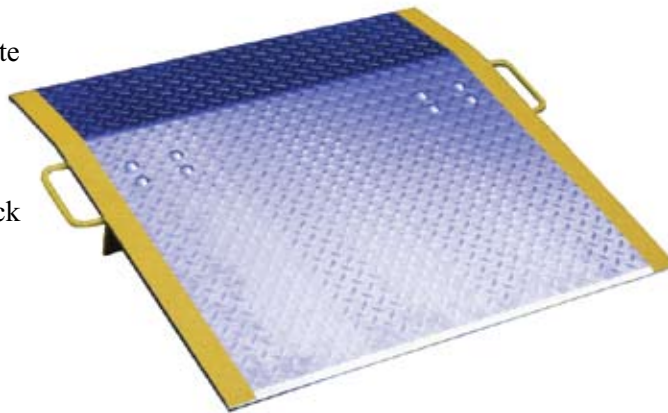

Dockplates are standard with 2 handles. Order with hand slots at no additional charge

THE BEST selling dock plates in America built by B&P Manufacturing. High traction, safety treadplate surface and beveled edges are only a few of the advantages of our dock plates. Made from high strength aluminum, our dock plates are available in capacities up to 10,000 pounds. Our weight capacities are actual capacities, assuming the entire load will be on the dock plate at once. Some companies assume that only 2 wheels of the load will be on at once, and overstate their capacity. As we have tested our dock plates to full capacity we are including that extra margin for safety.

Series "E" 3/8" Plate

Width	Max Ht. Dif.(In)	Size (WxL)	Leg Lgth.	Cap (Lbs)	Wt (Lbs)	Part #
30	3	30x24	7	3000	46	E-3024
30	4	30x30	7	2300	53	E-3030
30	5	30x36	7	1800	60	E-3036
30	7	30x48	9	1098	68	E-3048
36	3	36x24	7	3600	51	E-3624
36	4	36x30	7	3000	58	E-3630
36	5	36x36	7	2500	68	E-3636
36	7	36x48	9	1900	87	E-3648
42	3	42x24	7	4300	57	E-4224
42	4	42x30	7	3300	64	E-4230
42	7	42x48	9	2100	96	E-4248
48	3	48x24	7	5200	62	E-4824
48	4	48x30	7	4100	72	E-4830
48	5	48x36	7	3500	83	E-4836
48	6	48x42	9	3000	96	E-4842
48	7	48x48	9	2600	107	E-4848
48	8	48x54	12	2200	121	E-4854
48	10	48x60	12	1800	132	E-4860
54	3	54x24	7	5400	65	E-5424
54	4	54x30	7	4300	78	E-5430
54	5	54x36	7	3700	90	E-5436
54	7	54x48	9	2600	118	E-5448
54	10	54x60	12	2000	146	E-5460
60	3	60x24	7	5700	71	E-6024
60	4	60x30	7	4600	85	E-6030
60	5	60x36	7	4100	98	E-6036
60	6	60x42	9	3500	115	E-6042
60	7	60x48	9	2900	129	E-6048
60	8	60x54	12	2400	146	E-6054
60	10	60x60	12	2000	160	E-6060
72	4	72x30	7	5400	98	E-7230
72	5	72x36	7	4300	118	E-7236
72	7	72x48	9	3400	151	E-7248

Series "EH" 1/2" Plate

Width	Max Ht. Dif.(In)	Size (WxL)	Leg Lgth.	Cap (Lbs)	Wt (Lbs)	Part #
30	3	30x24	7	5200	55	EH-3024
30	4	30x30	7	4100	64	EH-3030
30	5	30x36	7	3500	72	EH-3036
30	7	30x48	9	2600	94	EH-3048
36	3	36x24	7	6200	62	EH-3624
36	4	36x30	7	5100	72	EH-3630
36	5	36x36	7	4300	82	EH-3636
36	7	36x48	9	3000	108	EH-3648
42	3	42x24	7	7200	68	EH-4224
42	4	42x30	7	5900	81	EH-4230
42	7	42x48	9	3500	123	EH-4248
48	3	48x24	7	8200	75	EH-4824
48	4	48x30	7	6300	90	EH-4830
48	5	48x36	7	5300	104	EH-4836
48	6	48x42	9	4300	122	EH-4842
48	7	48x48	9	3800	137	EH-4848
48	8	48x54	12	3300	154	EH-4854
48	10	48x60	12	2900	168	EH-4860
54	3	54x24	7	9100	83	EH-5424
54	4	54x30	7	7100	99	EH-5430
54	5	54x36	7	5300	114	EH-5436
54	7	54x48	9	4200	150	EH-5448
54	10	54x60	12	3400	185	EH-5460
60	3	60x24	7	10000	90	EH-6024
60	4	60x30	7	7800	108	EH-6030
60	5	60x36	7	6600	125	EH-6036
60	6	60x42	9	5500	148	EH-6042
60	7	60x48	9	4800	164	EH-6048
60	8	60x54	12	4100	189	EH-6054
60	10	60x60	12	3700	203	EH-6060
72	4	72x30	7	9500	125	EH-7230
72	5	72x36	7	7800	145	EH-7236
72	7	72x48	9	5900	191	EH-7248



COMPUTER BIN

Designed and built to safely hold and transport valuable computer monitors and equipment. Double thick 1-1/2" plywood shelves provide extra support and are solidly screwed in place, ample space is provided between shelves to handle the tallest monitors. Very stable bin under load. 4" Hi-Tech Rubber Casters standard.

Cabinet dimensions:

Height - 58"

Width - 48"

Depth - 22"

Shelf spacing:

Bottom 2 shelves - 23"

Open top shelf - 9"

LIBRARY BIN

Move books quickly and efficiently with this 4 shelf unit, all shelves are braced and screwed in place. 4" Hi-Tech Rubber Casters standard.

Cabinet dimensions:

Height - 48"

Width - 38"

Depth - 16"

Shelf spacing:

Bottom 3 shelves - 12"

Open top shelf - 9-1/2"



DOUBLE SIDED LIBRARY BIN

8-Shelf bin designed for quick and easy transport of books, legal documents, medical records, etc. There are 4 shelves on each of the two sides, solidly braced and screwed in place. 4" Hi-Tech Rubber Casters standard.

Cabinet dimensions:

Height - 48"

Width - 48"

Depth - 24"

Shelf depth - 11-7/8"

Shelf spacing:

Bottom 3 shelves - 12"

Open top shelf - 9-1/2"

SAMSON BOOK / UTILITY CARTS

These high density poly plastic carts are a 6 shelf double sided bin that is 25" deep, or you can fold up one side to make a single sided bin, the entire unit will fold up to 12 1/2" deep for storage. Rounded corners, no sharp edges, maintenance free bins that will hold 125 lbs. per shelf. All parts are replaceable. Comes standard with 5" soft, multi-surface swivel casters. Completely assembled, weighs 130 lbs.

OPTIONS:

- Cargo net
- Tamper evident locking cover with heavy duty zipper



Dimensions: Closed: 42" W x 12.5" D x 51" H Open: 42" W x 25" D x 51" H

CANVAS BASKET TRUCKS

Available in Traditional white canvas or grey water-proof vinyl coated nylon. Nylon is also available in a variety of bright colors. Hardwood frame with steel supports. Standard with 3" Hi-Tech soft rubber casters.

BUSHEL SIZE	INSIDE DIMENSIONS L X W X D	OUTSIDE DIMENSIONS L X W X H	CASTER SIZE	SHIPPING WEIGHT
6	30 x 20 x 20.5	31.5 x 21.5 x 26.5	3"	28 lbs
8	34 x 22 x 23	35.5 x 23.5 x 29	3"	34 lbs
10	36 x 24 x 25	37.5 x 25.5 x 31	3"	36 lbs
12	36 x 26 x 27.5	37.5 x 27.5 x 33.5	3"	39 lbs
14	40 x 28 x 27.5	41.5 x 29.5 x 33.5	3"	45 lbs
16	40 x 28 x 30	41.5 x 29.5 x 36	3"	46 lbs
18	42 x 30 x 30	43.5 x 31.5 x 36	3"	49 lbs
20	44 x 32 x 33	45.5 x 33.5 x 39	3"	54 lbs
SP20	48 x 32 x 30	49.5 x 33.5 x 36	3"	58 lbs
SP24	54 x 34 x 30	55.5 x 35.5 x 37	4"	60 lbs



We have been manufacturing dollies for the Moving & Storage Industry since 1953.

We understand the mover and his needs. Price is very important; our prices have always been low, but price without quality is no value.

Our dollies and every product we sell are of the highest quality. We stand behind every item we sell and demand that it perform to your complete satisfaction.

Sincerely,

Raymond Nacewicz

Neil Nacewicz

We can ship small orders U.P.S. Larger orders will be shipped common carrier. We receive large discounts off carrier rates, or our own trucks will deliver to a limited area for a nominal charge.

We are located only 2 minutes off I-95, 1-1/2 hours North of New York City.

NORTH BOUND

I-95 - Exit 29 "Stratford Ave." Go left at light and stay to your right. At next light, go right onto Stratford Ave. This is a one-way street. Follow for 1.1 miles, we are on the right hand side of the street at the corner of Bruce Blvd. and Stratford Ave.

SOUTH BOUND

I-95 - Exit 29 "Stratford Ave - Seaview Ave." Go left at the light at the bottom of the ramp. Go left at the next light onto Stratford Ave. This is a one-way street. Follow for 1.1 miles, we are on the right hand side of the street at the corner of Bruce Blvd and Stratford Ave.



ADAMS ASSOCIATES

“Moving Equipment and Supplies”

